

Example Four - Suitable for Open on One Side (Three walls) from 18sqm - 26sqm

This Document details 18sqm (4m x 4.5m). Please contact us for drawings of different sized areas

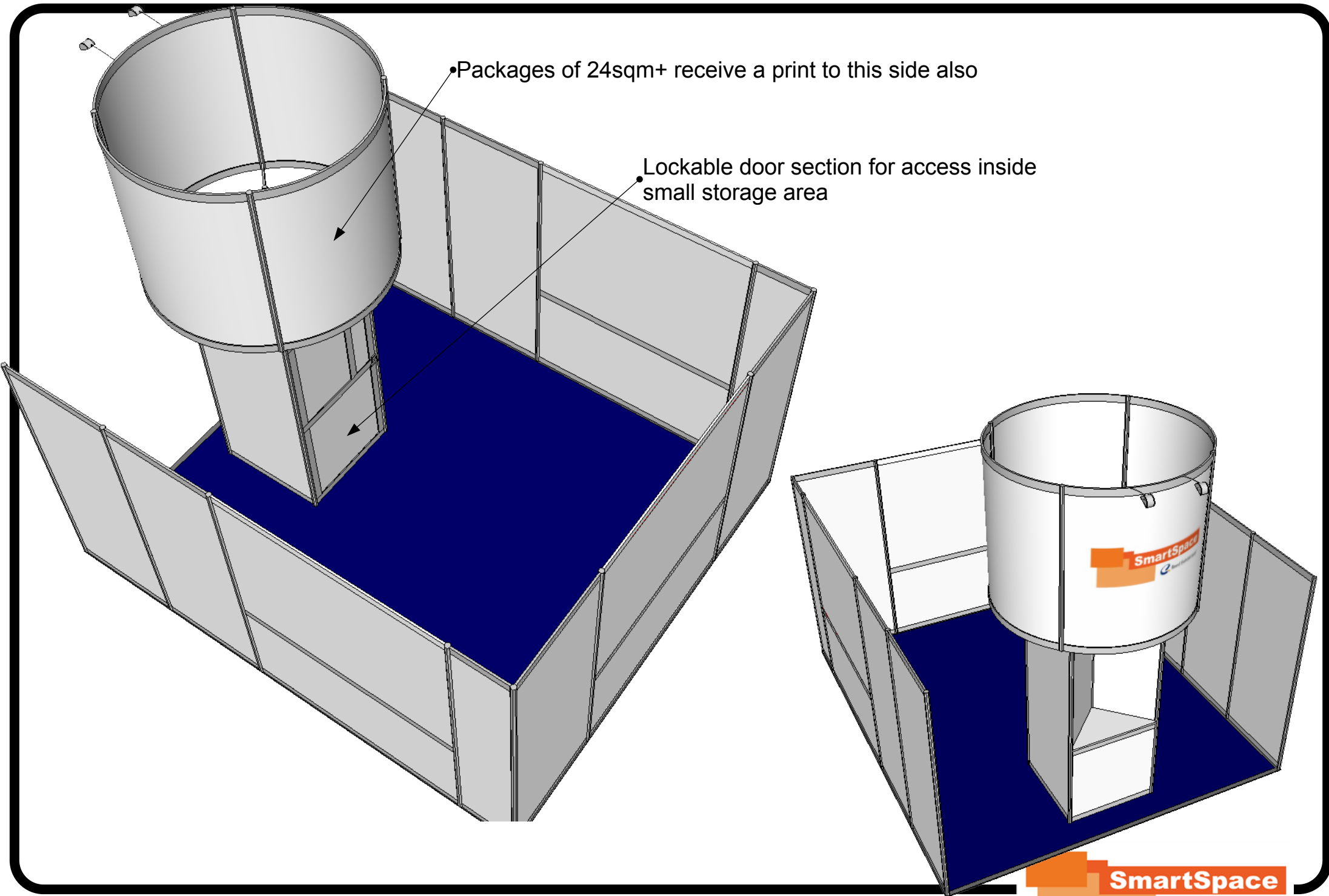

Raised fascia 1.0m high where venue ceilings allow. This design includes white as standard - other colours are available

Print your logo to this panel

Product display triangle
Base is 1m high with white worktop
Colour upgrades available, plus upgrades to add shelving or additional lighting

Cord carpet laid direct to venue floor
(in some venues, cables may be visible on floor)
Colour choice, plus upgrades available

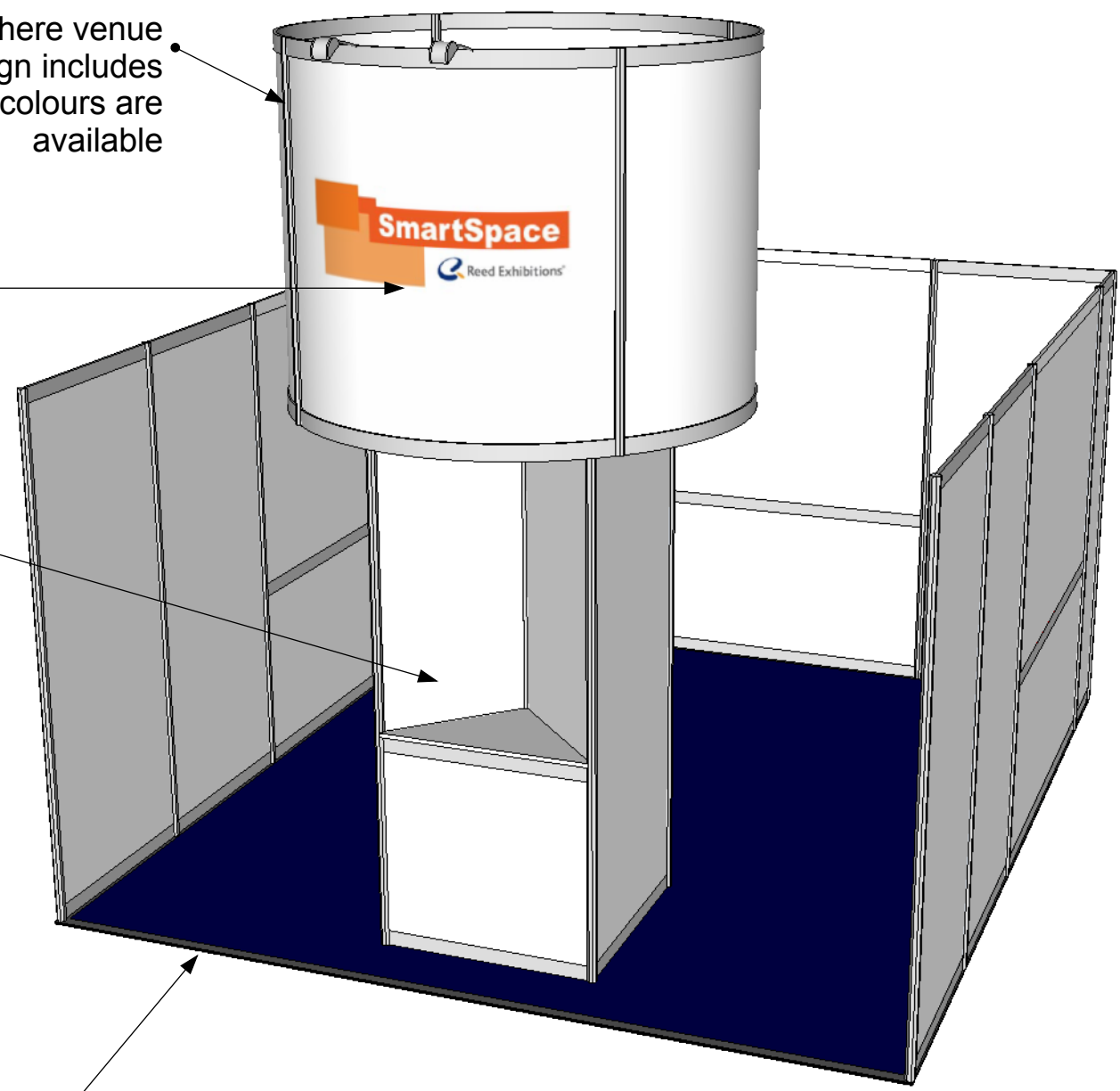

Perimeter walling is 2.5m high with white panels. Colour upgrades are available

Space for seating and product display. Furniture is not included within the SmartSpace package - Please see Additional Items

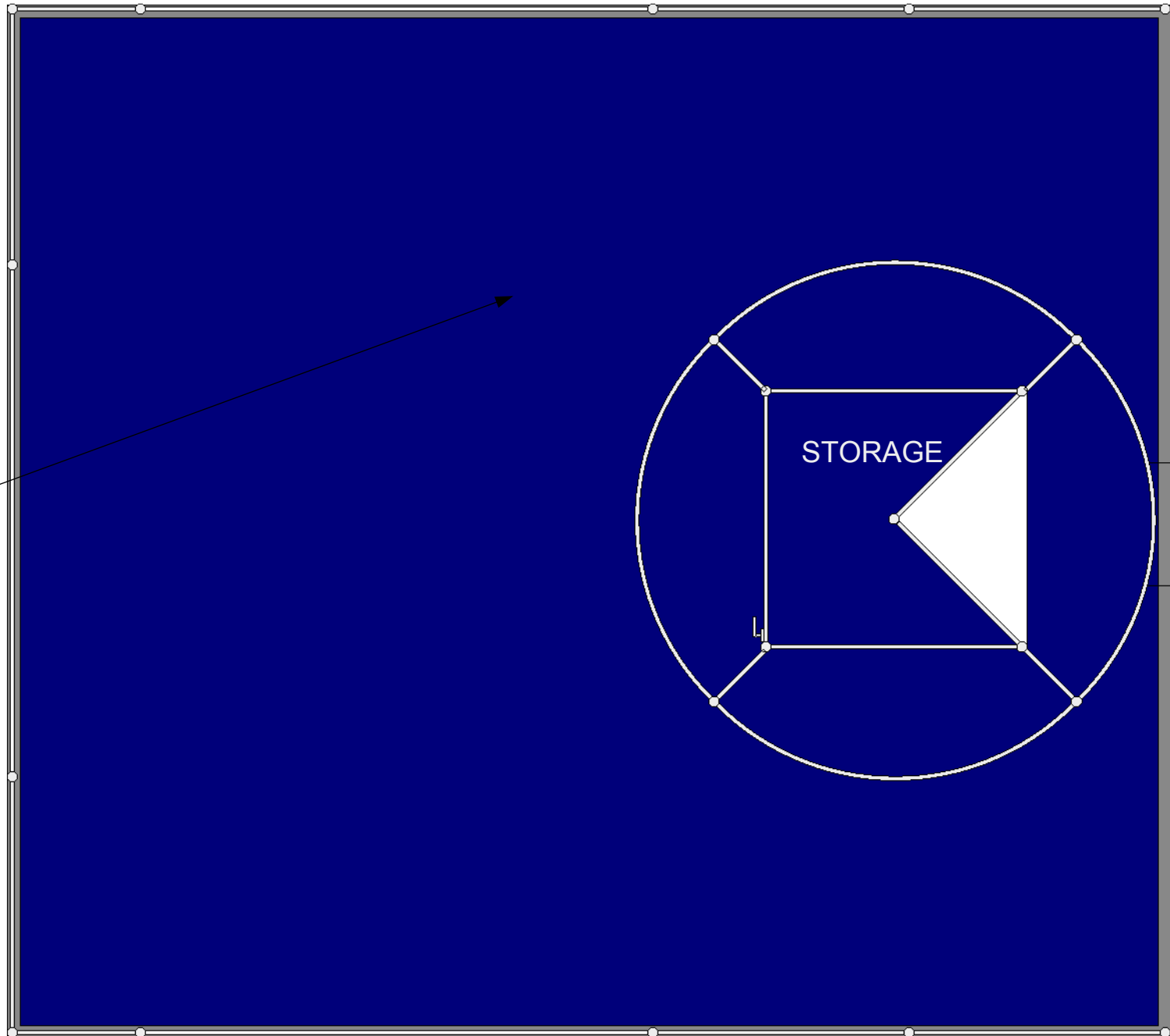

Electrical Items:

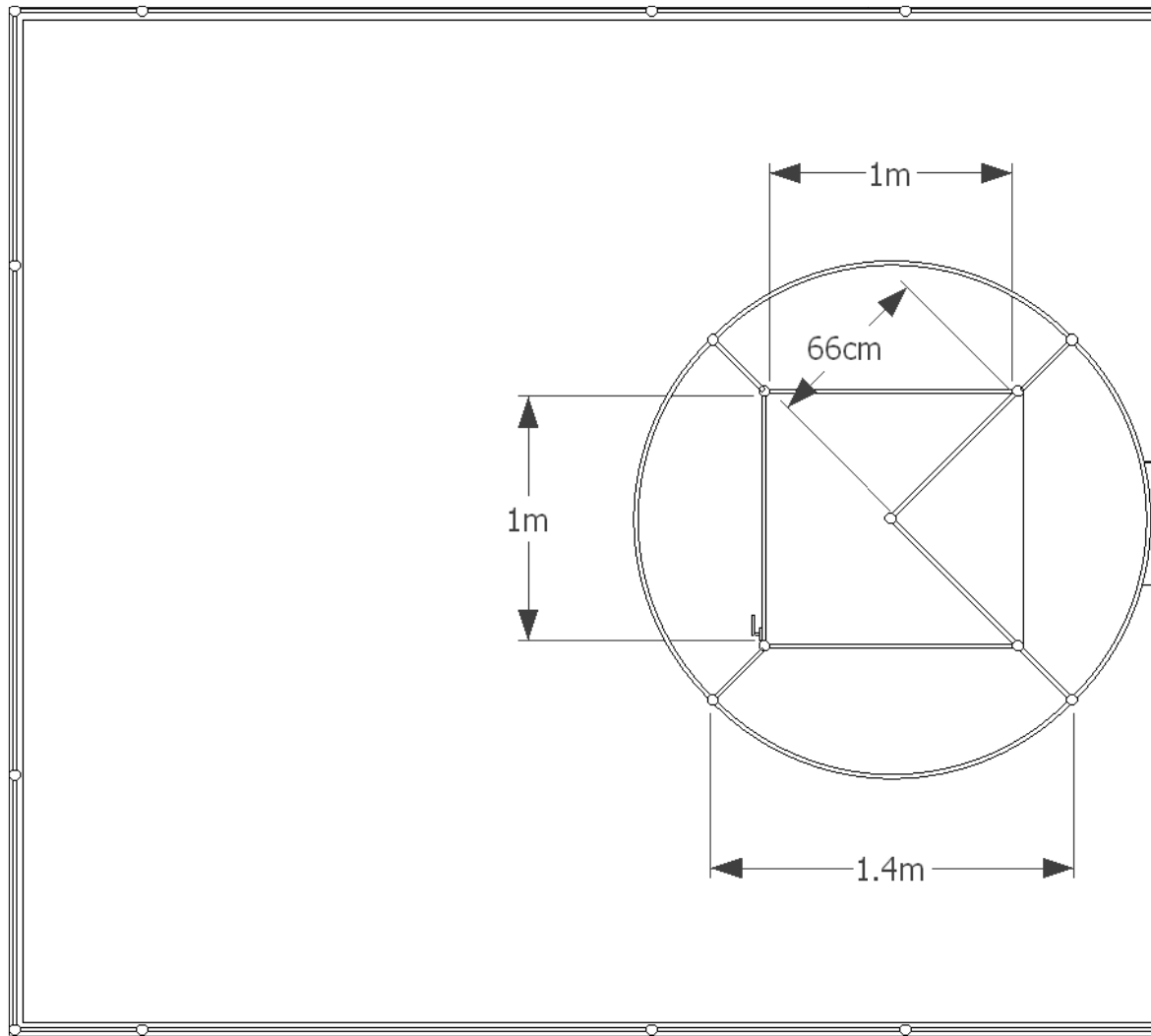

18sqm - 19sqm:
Package includes 2no Spotlights

20sqm - 21sqm:
Package includes 2no Spotlights, plus
1no Single Socket

22sqm - 26sqm
Package includes 4no Spotlights, plus
1no Single Socket

Each stand will have an electrical mains cable leading to an electrical mains box. These units are compulsory and cannot be removed. In all cases we will attempt to minimise the view of these boxes by hiding them away in storage areas or in discreet places on the stand

In European venues, there will be an Additional Item charge for Consumption.

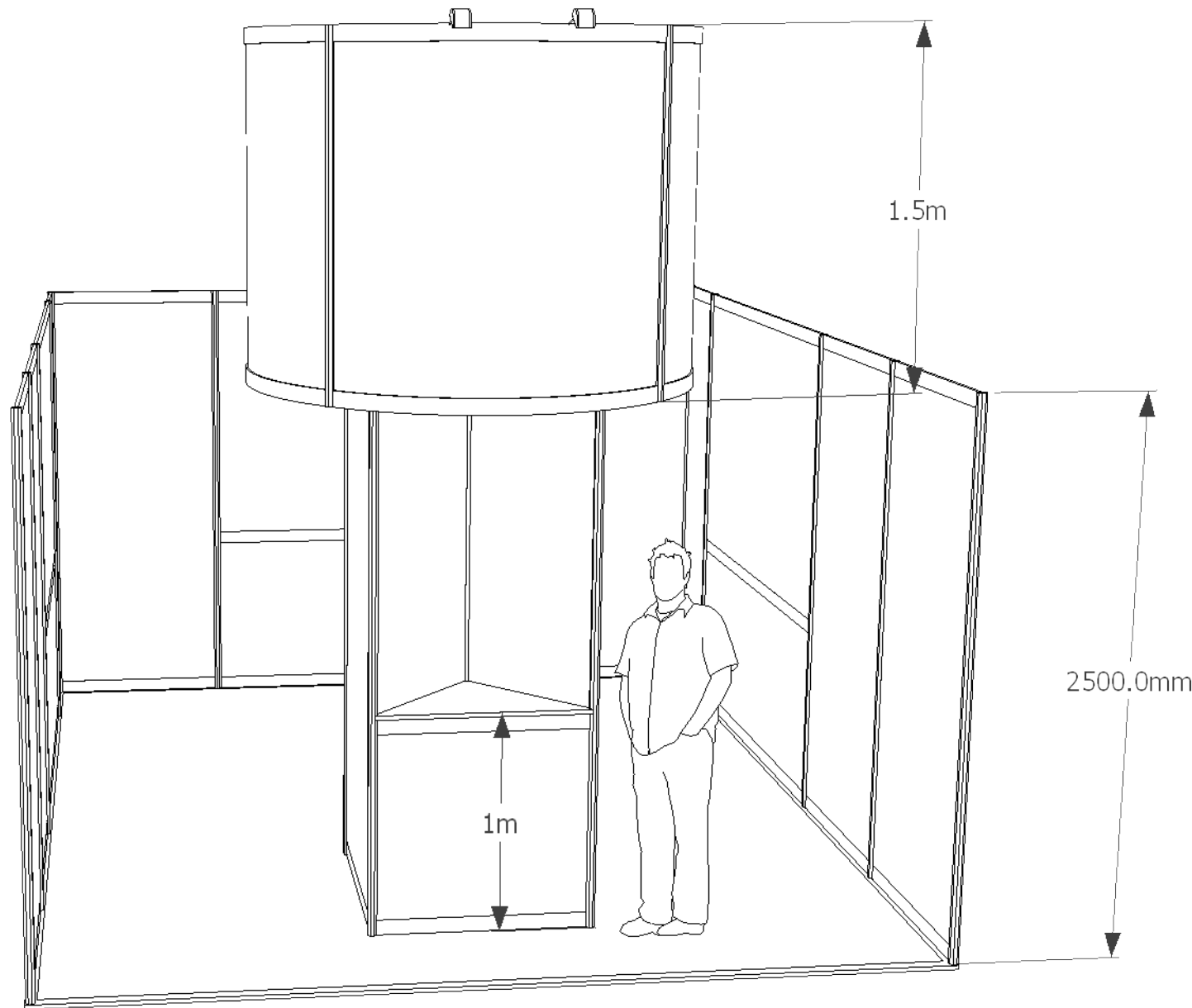

Where Venue Ceiling Heights allow, build will be 4.0m high - 2.5m high walling with 1.5m high Raised Fascia

All counters / desks / Pods are 1m high

Artwork Panels:

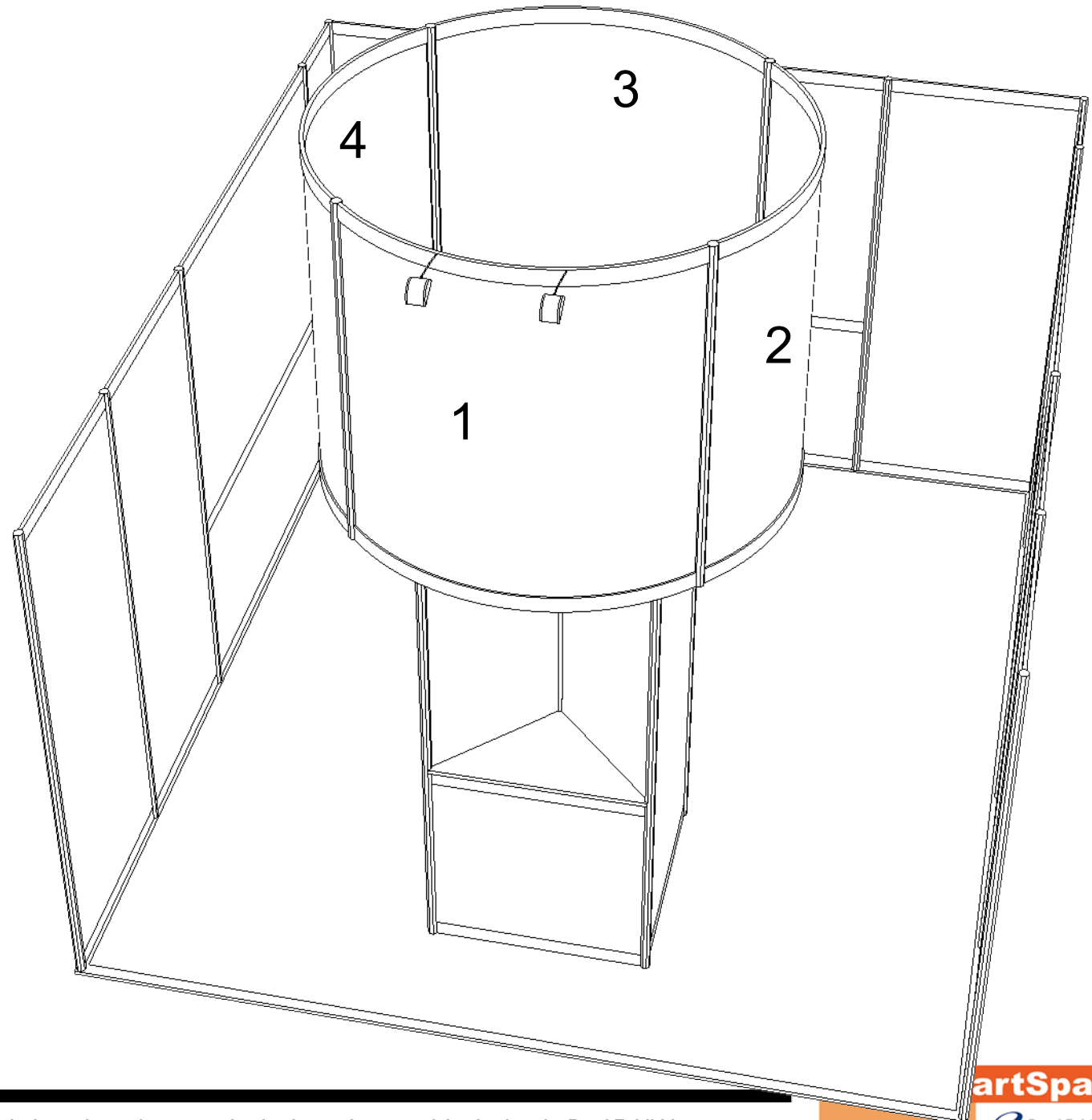

When you have booked your stand and chosen your design, we will send you a set of drawings specific to your stand size.

We will provide you with the sizes of each panel that you wish to provide artwork to print

| Suitable Formats for images or logos | |
|--------------------------------------|-----------------------|
| Programme | Preferred Format |
| Adobe Illustrator | ai, eps |
| Adobe Photoshop | psd, tiff, eps, jpeg* |
| Adobe InDesign | .indd, |
| QuarkXpress | qxd |
| Adobe Acrobat | PDF** |

| Formats NOT Suitable for images or logos | |
|--|----------|
| Programme | Format |
| Word | doc, txt |
| PowerPoint | ppt |
| Website | gif |

Please contact us for the sizes of each numbered Panel

Vectors

Text @ 100%



Outlined text



gif
@ 400%



ai / eps vector
@ 400%



Low Resolution
(72dpi) jpeg 88 Kb



High Resolution
(300dpi) jpeg 3.52 Mb

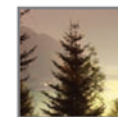
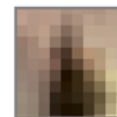

No responsibility will be taken for the accuracy of any artwork recreated due to poor quality

Vector Artwork

Artwork which is going to be produced in vinyl, for example; solid company logo's or text, must be supplied in a **vector format (ai or vector eps)**. Artwork created in a pixel format i.e. TIFF and JPEG is not suitable.

Fonts

Supply all relevant fonts and scans used. Please outline any text if it is not possible to supply the typeface.

Images

Please supply high resolution images or photographs, pdf and hard copy colour proofs with your artwork.

Image Quality

For the best quality, artwork should be created in **vector format (ai or vector eps)**. Logos taken from websites are generally gif's. **Gif files are not acceptable as they will not print clearly**, See Visual.

Artwork should be created at actual size, however for larger files i.e. Banner artwork, 10% or 25% of actual size is acceptable. Scans should be no smaller than 300dpi at quarter size. Please include all links (images, logos, fonts).

Microsoft Word and Excel are for text only, logos and images inserted will not be high enough quality for large format printing. Powerpoint files are also not recommended as images are often very low resolution.

***JPEG** - We accept this format but only if used to compress a file for ease of sending, the original artwork should have been created high resolution - **300dpi** (see visual) or vector eps to print at the best possible quality.

****PDF** different sizes, artwork must be set up at the correct proportion and at print ready quality. Make sure images are saved at high resolution (300dpi).

Colour Set Up

If your artwork is set up using PANTONE Colours please supply a Pantone colour reference. Some colours are more likely to be achieved, however due to printer limitations Pantone colours are matched to their best possible interpretation for the specific output device. Hard copies such as brochures or print outs can also be used as a reference for colour matching. All essential colour matches need to be specifically noted in the file and by e-mail.

Colour accuracy can not be guaranteed from CMYK or RGB files.

Do not set colours to 'Overprint'

Artwork Panel Sizes

These are visual panel sizes - Artwork Bleed is not included in these sizes.

Uploading Artwork

We will set you up with a temporary user account 2 weeks prior to the artwork deadline. When we download your files you will receive a receipt. **Please save all files using the references above for positioning purposes.**

Artwork Bleed

Please add 6mm bleed all round your artwork at 100%, If supplying artwork for banners and banner wraps, please add 150mm bleed at 100% to all sides of the artwork, this will allow for any banner pockets and wrapping of pvc to frames and walls.

